

Operating instructions

Wine Cellar

Read the operating instructions before switching on for the first time

Page 6

GB

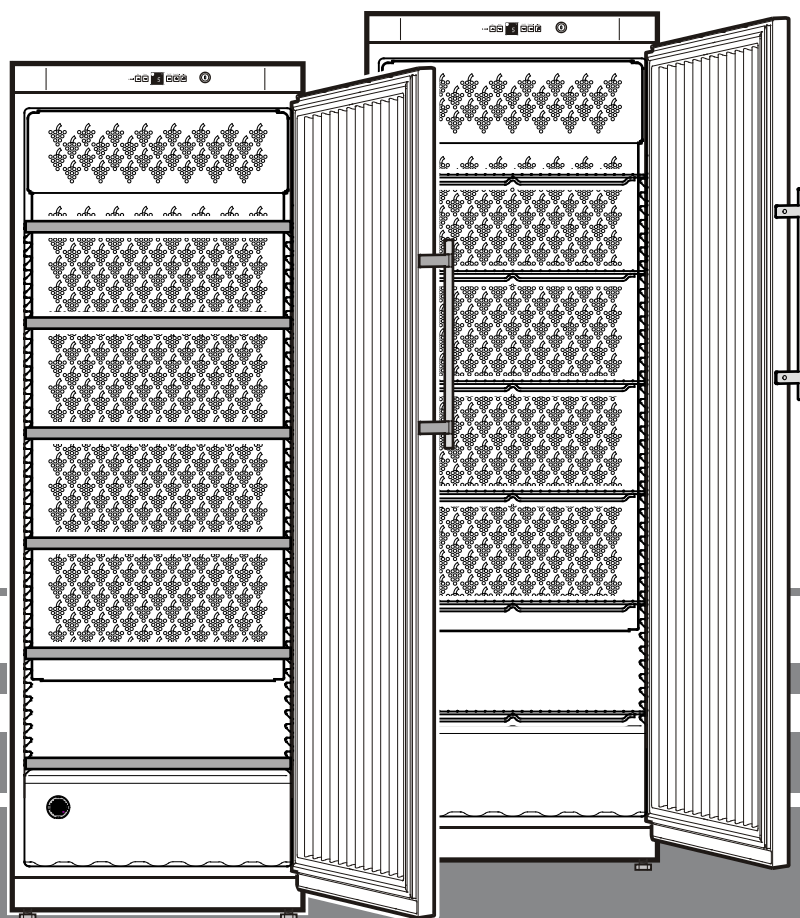

7081 203-00

WK/GWK 211

LIEBHERR

Disposal notes

The appliance contains some reusable materials and should be disposed of properly - not simply with unsorted household refuse. Appliances which are no longer needed must be disposed of in a professional and appropriate way, in accordance with the current local regulations and laws.



When disposing of the appliance, ensure that the refrigeration circuit is not damaged to prevent uncontrolled escape of the refrigerant it contains (data on type plate) and oil.

- Disable the appliance.
- Pull out the plug.
- Cut through the connecting cable.

! WARNING

Danger of suffocation due to packing material and plastic film! Do not allow children to play with packing material. Take the packing material to an official collecting point.

Range of appliance use

The appliance is suitable solely for storing wine in a domestic environment or similar. This includes use in, for example

- in staff kitchenettes, bed and breakfast establishments,
- by guests in country homes, hotels, motels and other forms of accommodation,
- in catering and similar services in the wholesale trade.

Use the appliance solely as is customary within a domestic environment. All other types of use are inadmissible. The appliance is not suitable for storing and cooling medicines, blood plasma, laboratory preparations or similar substances and products covered by the 2007/47/EC Medical Devices Directive. Misuse of the appliance can result in the stored products suffering harm or perishing. Furthermore, the appliance is not suitable for operation in potentially explosive atmospheres.

Description of appliance and equipment

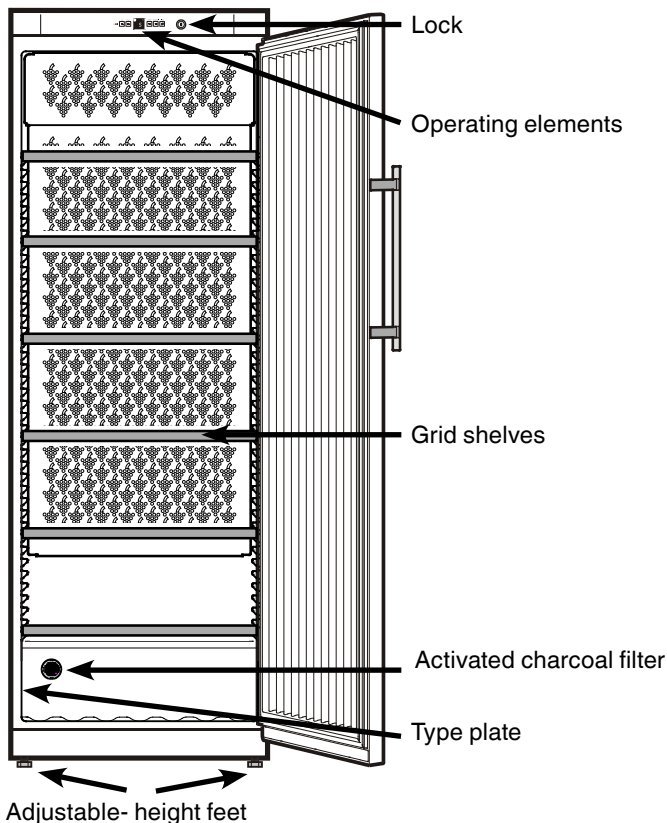

Safety instructions and warnings

- To prevent injury or damage to the unit, the appliance should be unpacked and set up by two people.
- In the event that the appliance is damaged on delivery, contact the supplier immediately before connecting to the mains.
- To guarantee safe operation, ensure that the appliance is set up and connected as described in these operating instructions.
- Disconnect the appliance from the mains if any fault occurs. Pull out the plug, switch off or remove the fuse.
- When disconnecting the appliance, pull on the plug, not on the cable.
- Any repairs and work on the appliance should only be carried out by the customer service department, as unauthorised work could prove highly dangerous for the user. The same applies to changing the mains power cable.
- Do not allow naked flames or ignition sources to enter the appliance. When transporting and cleaning the appliance ensure that the refrigerant circuit is not damaged. In the event of damage, make sure that there are no ignition sources nearby and keep the room well ventilated.
- Do not stand on the plinth, drawers or doors or use them to support anything else.
- This appliance is not intended for use by persons (including children) with reduced physical, sensory or mental capabilities or lack of experience and knowledge unless they have been given initial supervision or instruction concerning use of the appliance by a person responsible for their safety. Children should be supervised to ensure that they do not play with the appliance.
- Avoid prolonged skin contact with cold surfaces or chilled/frozen food. This could cause pain, numbness and frostbite. In the case of prolonged skin contact, protective measures should be taken, e.g. gloves should be worn.
- Do not consume food which has been stored for too long, as it could cause food poisoning.
- Do not store explosives or sprays using combustible propellants such as butane, propane, pentane etc. in the appliance. Electrical components might cause leaking gas to ignite. You may identify such sprays by the printed contents or a flame symbol.
- Do not use electrical appliances inside the appliance.
- If you have a lockable appliance, do not keep the key near the appliance or within reach of children.
- The appliance is designed for use in enclosed areas. Do not operate the appliance outdoors or in areas where it is exposed to splash water or damp conditions.
- Special-purpose lamps (incandescent lamps, LEDs, fluorescent tubes) in the appliance serve to illuminate the appliance interior and are not suited for room illumination.

Climate rating

The appliance is set to operate within specific ambient temperature limits according to its climate rating. These temperature limits should not be exceeded. The correct climate rating for your appliance is indicated on the type plate.

Climate rating	Ambient temperature
SN	+10°C to +32°C
N	+16°C to +32°C
ST	+16°C to +38°C
T	+16°C to +43°C

The appliance complies with the relevant safety regulations and EC directives 2004/108/EC and 2006/95/EC.

Setting up

- Avoid positioning the appliance in direct sunlight or near cookers, radiators and similar sources of heat.
- The floor on which the appliance stands should be horizontal and level. Compensate for uneven floors with the adjustable feet.
- Always ensure that there is good ventilation and that the outward flowing air is able to escape.
- Standard EN 378 specifies that the room in which you install your appliance must have a volume of 1 m³ per 8 g of R 600a refrigerant used in the appliance, so as to avoid the formation of inflammable gas/air mixtures in the room where the appliance is located in the event of a leak in the refrigerant circuit. The quantity of refrigerant used in your appliance is indicated on the type plate on the inside of the appliance.
- Do not connect the appliance to the supply with other equipment using an extension cable - risk of overheating.
- Always install the appliance directly against the wall.

Dimensions

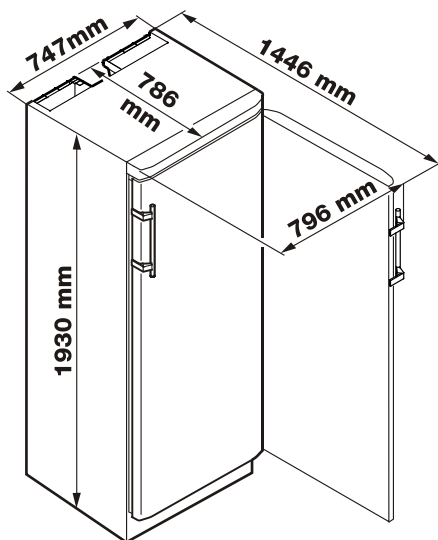

Connecting to the mains

Power supply (a.c.) and voltage at the operating point must comply with the details on the type plate. The socket must be fused with a 10 A fuse or higher, it must be away from the rear of the appliance and must be easily accessible.

Connect the appliance with a properly earthed fused plug and socket only.

Operating and control elements

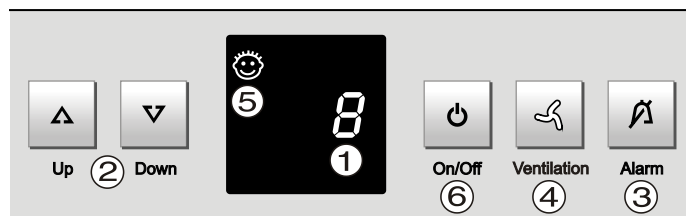

- ① Temperature display
- ② Temperature setting buttons
- ③ Audible warning on/off button
- ④ Fan on/off button
- ⑤ Child-proof lock
- ⑥ On/off button

Switching the appliance on and off

You are recommended to clean the appliance before switching it on for the first time (see **Cleaning**). Connect the appliance to the mains - the appliance is switched on.

- **To switch the appliance on:** Press the **ON / OFF** button until the Display lights up.
- **To switch the appliance off:** Keep the **ON / OFF** button pressed for 3 sec. so that the temperature display goes out.

Setting the temperature

To reduce the temperature: Press the **DOWN** button;

To increase the temperature: Press the **UP** button.

- While you are entering the temperature, the set temperature will flash on the display.
- You can change the settings in increments of 1°C briefly pressing the button again.
- The electronic controls will switch over automatically about 5 seconds after the last time you pressed the button, and the actual temperature will be displayed.

If **F 1** appears in the display, the appliance has a fault. Consult your nearest customer service point.

Fan switch

Thereby a climate which corresponds to that of a wine cellar is achieved inside the wine cooler. Corks are prevented from drying out due to an increased level of humidity.

To switch on: Press the **Ventilation** button. The indicator lamp in the switch will light up.

To switch off: Press the **Ventilation** button. The indicator lamp in the switch goes dark.



Ventilation

Storing wine

If you are storing wine for long periods of time, it should be stored at a temperature of between 10°C and 14°C.

This is the temperature wine cellars are kept at, and it is just right to allow wine to mature properly.

The following drinking temperatures are recommended for the various types of wine.

- Red wines: **+14°C to +18°C**
- Rosé wines: **+10°C to +12°C**
- White wines: **+8°C to +12°C**
- Sparkling wines, Prosecco **+7°C to +9°C**
- Champagne **+5°C to +7°C**

Caution!

The maximum load capacity of the wood racks is 80 kg.

Audible warning signal

The audible warning signal helps to protect your wines against excessive temperature fluctuations.

- It sounds when the door has been left open for longer than about 60 seconds. The audible warning device is switched off by pressing the "Alarm" button.



- It sounds when the interior gets too warm or too cold. The temperature display will also flash. The audible warning device is switched off by pressing the "Alarm" button. The temperature display will continue to flash until the cause of the alarm has been rectified.

Additional functions

In set-up mode you can set the child-proof lock and adjust the brightness of the display. The child-proof lock is designed to protect the appliance from being switched off accidentally.

Activating set-up mode:

- Press **Ventilation** button for approx. 5 secs.
 - The display shows **c** for child-proof lock.
 - Note: The value to be altered flashes.
- Select the required function by pressing the **Up/Down** button:
 - c** = child-proof lock, **h** = brightness of the display
- Now select/acknowledge the function by pressing the **Ventilation** button briefly:

> For **c** = **child-proof lock**, press the **Up/Down** button to select

c1 = child-proof lock **on** or

c0 = child-proof lock **off** and acknowledge with the **Ventilation** button.

When the symbol ☺ is lit, the child-proof lock is activated.



> For **h** = **brightness**, press the **Up/Down** button to select

h1 = minimum or

h5 = maximum brightness and acknowledge with the **Ventilation** button.

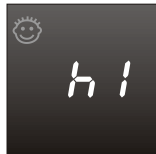

Exiting set-up mode:

Exit the set-up mode by pressing the On/Off button; after 2 min. the electronic system switches over automatically. The normal operating mode is activated again.

Interior light

Bulb data: 15 W (never use a bulb rated at more than 15 W). The voltage should agree with the details on the type plate.
Socket: E 14.

Replacing the bulb:
Pull out the mains plug or remove/unscrew the fuse.

Change the bulb behind the operating panel.

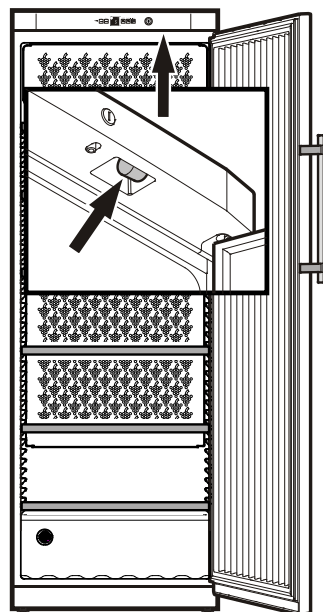

Air exchange with activated charcoal filter

The way in which wines continue to mature depends on the ambient conditions. The quality of the air is therefore decisive for preserving the wine.

We recommend that you replace the filter once a year. Filters can be obtained from your dealer.

Changing the filter:

Take the filter by the handle. Turn it 90° to the left or right and remove.

Inserting the filter:

Insert with the handle in a vertical position. Turn it 90° to the left or right until it clicks into place.

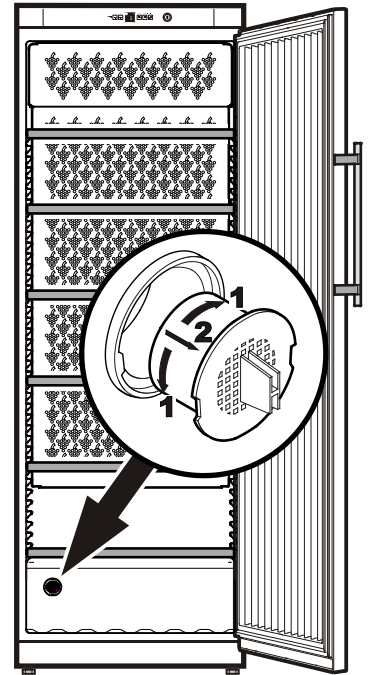

Safety lock

Locking the appliance:

- Insert the key as shown by arrow 1.
- Turn the key 90°.

To unlock the appliance, the same procedure must be repeated in the same order.

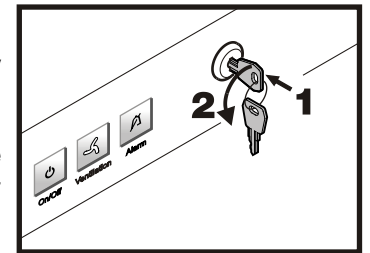

Defrosting

The appliance defrosts automatically.

Cleaning

Before cleaning always switch off the appliance. Pull out the mains plug or remove/unscrew the fuse.

- Clean the inside, equipment and outer walls with lukewarm water and a little detergent. Do not use abrasive or acid cleaners or chemical solvents.

Do not use steam cleaners because of the risk of injury and damage.

- Ensure that no cleaning water penetrates into the electrical components or ventilation grille.
- The dust should be removed from the refrigeration unit and heat exchanger - metal grid at the back of the appliance - once a year.
- Do not damage or remove the type plate on the inside of the appliance. It is very important for servicing purposes.

Malfunions

You may be able to rectify the following faults by checking the possible causes yourself:

- Appliance does not function:
 - Is the appliance switched on?
 - Is the plug correctly fitted in the mains socket?
 - Is the socket fuse intact?
- Loud running noise:
 - Is the appliance set up firmly on the floor?
 - Does the appliance cause nearby items of furniture or objects to vibrate? Ensure that the appliance is stable and that all parts at the back can vibrate freely. Please note that noises caused by the refrigerant circuit cannot be avoided.
- The temperature is not low enough:
 - Is the temperature setting correct (see „Setting the temperature“)?
 - Does the separately installed thermometer show the correct reading?
 - Is the ventilation system working properly?
 - Is the appliance set up too close to a heat source?

If none of the above causes apply and you cannot rectify the fault yourself, contact the nearest customer service department stating the type of appliance ①, service number ② and appliance number ③ as indicated on the type plate. The type plate is located in the refrigerator compartment on the left-hand side.

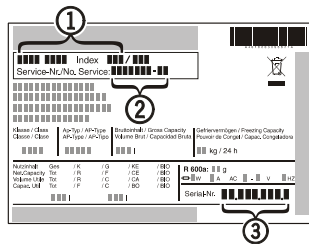

Shutting your appliance down

If your appliance is to be shut down for any length of time, switch it off and disconnect the plug or remove the fuse. Clean the appliance and leave the door open in order to prevent unpleasant smells.

The appliance complies with the relevant safety regulations and EC directives 2004/108/EC and 2006/95/EC.

All types and models are subject to continuous improvement and the manufacturer therefore reserves the right to make modifications to the shape, equipment and technology.

Changing over door hinges

1. Remove screw from lower hinge bracket.

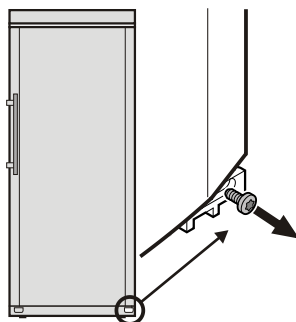

2. Lift door 1, tilt to the right 2 and remove 3.

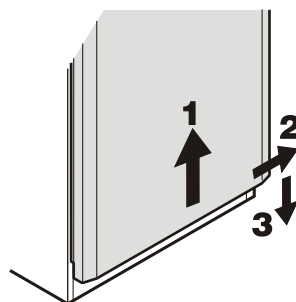

3. Transfer handle to the opposite side.

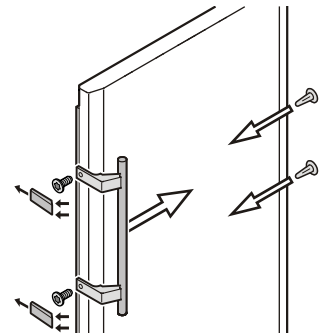

4. Transfer pin to the opposite side of the door.

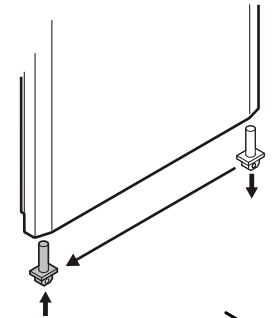

5. Transfer upper hinge components to the opposite side.

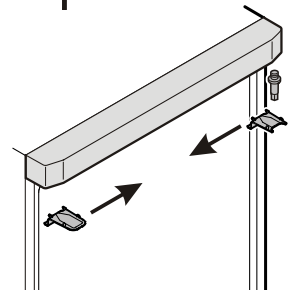

6. Transfer lower hinge bracket to the opposite side.

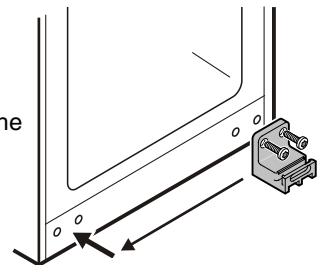

7. Locate door on upper pin.

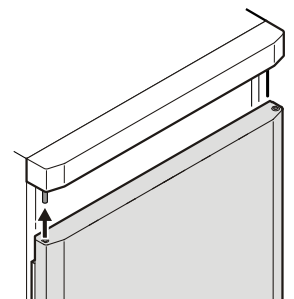

8. Tilt door inwards from the left 1. Secure hinge pin with screw 2.

