

ANDI

Instruction Manual

AF607CEX

Dishwashers

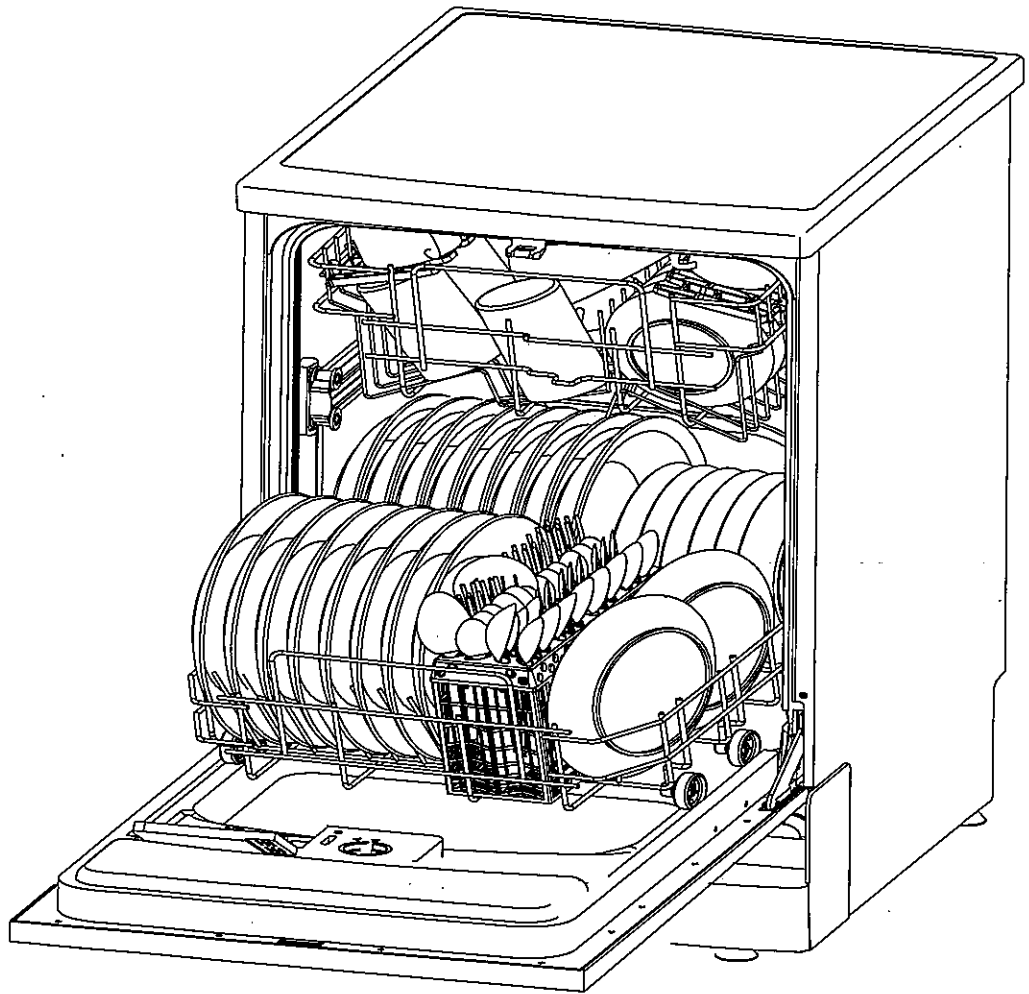



Read this Manual

Dear Customer,

Please read this User Information carefully and keep it to refer to at a later date.

Pass it on to any subsequent owner of the appliance.

This manual contains sections of Safety Instructions, Operating Instructions, Installation Instructions and Troubleshooting Tips etc.

Carefully reading it before using the dishwasher will help you to use and maintain the dishwasher properly.



Before Calling for Service

To review the section on Troubleshooting Tips will help you to solve some common problems by yourself and not need to ask for the help of professional technicians.



NOTE:

The manufacturer, following a policy of constant development and up-dating of the product, may make modifications without giving prior notice.

1) Safety Information.....	1
2) Operating Instructions	
Control Panel.....	2
Dishwasher Features.....	2
3) Prior using for the first time.....	
Rinse Aid.....	3, 4
Detergent.....	5
How to use the 3in1 programme.....	6
4) Loading the Dishwasher Rack.....	
Not suitable for the dishwasher.....	8
At the end of the wash cycle	9
5) Starting a washing Programme	
Wash Cycle Table.....	10
Turning on the Appliance.....	11
Change the Programme.....	11
Forget to add a Dish.....	12
6) Maintenance and cleaning.....	
Filtering System.....	12
Caring for the Dishwasher.....	12,13, 14
7) Installation instruction	
About Electricity Connecting.....	14
Water Connection.....	15
Connection of drain hoses.....	15,16
Start of dishwasher.....	16
8) Troubleshooting Tips	
Before calling for service.....	17, 18
Error codes.....	18
Technical information.....	19

1. IMPORTANT SAFETY INFORMATION

READ ALL INSTRUCTIONS BEFORE USING

WARNING!

When using your dishwasher, follow the below basic precautions including the following:



WARNING! HYDROGEN GAS IS EXPLOSIVE

Under certain conditions, Hydrogen gas may be produced in a hot-water system that has not been used for two weeks or more. HYDROGEN GAS IS EXPLOSIVE. If the hot-water system has not been used for such a period, before using the dishwasher turn on all hot-water faucets and let the water flow from each for several minutes. This will release any accumulated hydrogen gas. As the gas is flammable, do not smoke or use an open flame during this time.

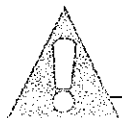

WARNING! PROPER USE

- Do not abuse, sit on, or stand on the door or dish rack of the dishwasher
- Do not touch the heating element during or immediately after use
- Do not operate your dishwasher unless all enclosure panels are properly in place. Open the door very carefully if the dishwasher is operating. There is a risk of water squirting out.
- Do not place any heavy objects on the door when it is open, or the appliance could tip forward.
- When loading items to be washed:
 - Locate sharp items so that they are not likely to damage the door seal;
 - Load sharp knives with the handles up to reduce the risk of cut-type injuries;
 - Warning: knives and other utensils with sharp points must be loaded in the basket with their points down or placed in a horizontal position.
- When using your dishwasher, you should prevent plastic items from contacting with heating element.
- Check that the detergent receptacle is empty after completion of the wash cycle.
- Do not wash plastic items unless they are marked dishwasher safe or the equivalent. For plastic items not so marked, check the manufacturer's recommendations.
- Use only detergent and rinse additives designed for an automatic dishwasher. Never use soap, laundry detergent, or hand washing detergent in your dishwasher.
- Keep children away from detergent and rinse aid, keep children away from the open door of the dishwasher, there could still be some detergent left inside.
- Young children should be supervised to ensure that they do not play with the appliance.
- The appliance is not intended for use by young children or infirm persons without supervision.
- Dishwasher detergents are strongly alkaline. They can be extremely dangerous if swallowed. Avoid contact with skin and eyes and keep children away from the dishwasher when the door is open.
- The door should not be left in the open position since this could present a tripping hazard.
- This dishwasher is designed for normal household and indoor use.
- If the supply cord is damaged, it must be replaced by the manufacturer or its service agent or a similarly qualified person in order to avoid a hazard.
- Please dispose of packing materials properly.
- Use the dishwasher only for its intended function.
- During installation, the power supply must not be excessively or dangerously bent or flattened.
- Do not tamper with controls.
- The appliance is to be connected to the water mains using new hose sets and the old hose-sets should not be reused.
- This appliance is not intended for use by persons (include children) with reduced physical, sensory or mental capabilities, or lack of experience and knowledge, unless they have been given supervision or instruction concerning use of the appliance by a person responsible for their safety
- Please unplug before cleaning the appliance.

READ AND FOLLOW THIS SAFETY INFORMATION CAREFULLY

SAVE THESE INSTRUCTIONS

2. Operation Instruction

IMPORTANT!

To get the best performance from your dishwasher, read all operating instructions before using it for the first time.

Control Panel

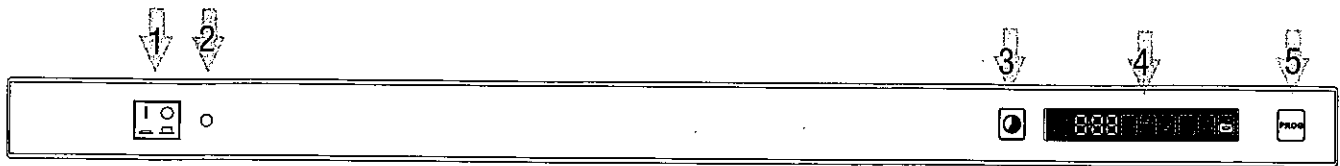

- 1 Power Switch: Turn on/off the power supply.
- 2 Power/ON Light: To come on when the ON/OFF Button is pressed down.
- 4 Delayed Start Button: Press this button to set the delayed hours for washing. You can delay the start of washing up to 24 hours. One press on this button delays the start of washing by half an hour.
- 5 Display Window: Delay time, the program, running indicator, fault codes and etc. .
- 6 Program button : Press this button to choose the desired program.

Dishwasher Features

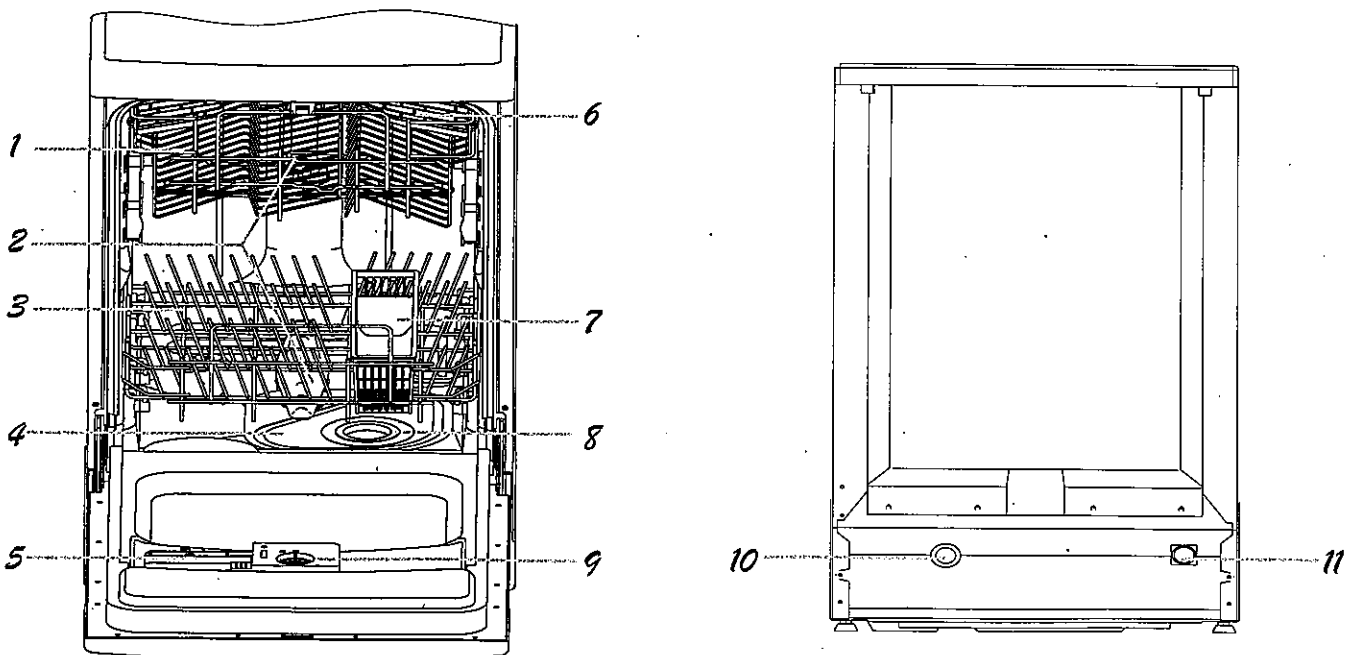

- | | | | |
|----------------|-----------------------|-----------------------|-------------------------|
| 1 Upper Basket | 4 Main Filter | 7 Silverware Basket | 10 Drain pipe connector |
| 2 Spray Arms | 5 Detergent Dispenser | 8 Coarse Filter | 11 Inlet pipe connector |
| 3 Lower Basket | 6 Cup Shelf | 9 Rinse Aid Dispenser | |

3. Prior using for the first time

Before using your dishwasher for the first time:

- A. Fill the rinse aid dispenser
- B. Function of detergent

A. Fill the Rinse Aid Dispenser

Function of Rinse Aid

Rinse aid is automatically added during the last rinse, ensuring thorough rinsing, spot and streak free drying.

Attention!

Only use branded rinse aid for dishwasher. Never fill the rinse aid dispenser with any other substances (e.g. dishwasher cleaning agent, liquid detergent). This would damage the appliance.

When to Refill the Rinse Aid Dispenser

If there is no rinse-aid warning light in the control panel, you can judge the amount of rinse-aid by the color of the optical level indicator "D" located next to the cap. When the rinse-aid container is full, the whole indicator will be dark. As the rinse-aid diminishes, the size of the dark dot decreases. You should never let the rinse aid get below 1/4 full.

As the rinse aid diminishes, the size of the black dot on the rinse aid level indicator changes, as illustrated right.

- Full
- 3/4 full
- 1/2 full
- 1/4 full – Should refill to eliminate spotting
- Empty

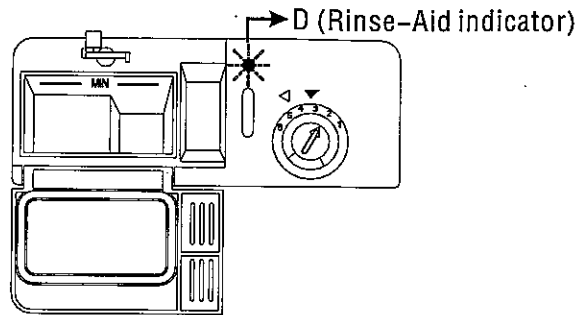

RINSE AID DISPENSER

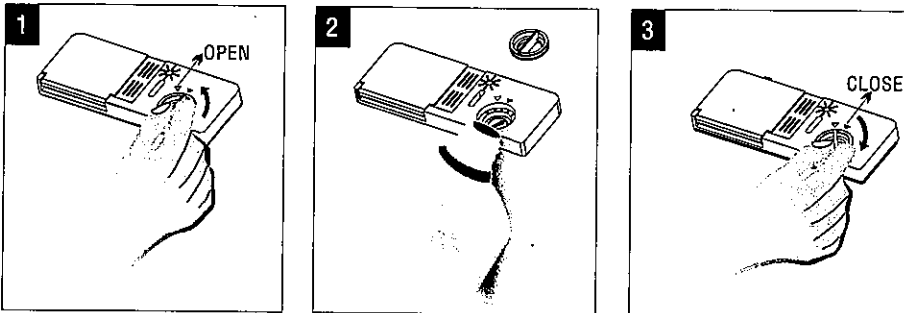

- 1 To open the dispenser, turn the cap to the "open" (left) arrow and lift it out.
- 2 Pour the rinse aid into the dispenser, being careful not to overfill.
- 3 Replace the cap by inserting it aligned with "open" arrow and turning it to the closed (right) arrow.

The rinse aid is released during the final rinse to prevent water from forming droplets on your dishes that can leave spots and streaks. It also improves drying by allowing water to sheet off the dishes. Your dishwashers are designed to use liquid rinse aids. The rinse aid dispenser is located inside the door next to the detergent dispenser. To fill the dispenser, open the cap and pour the rinse aid into the dispenser until the level indicator turns completely black. The volume of the rinse aid container is about 140ml.

Be careful not to overfill the dispenser, because this could cause over sudsing. Wipe away any spills with a damp cloth. Don't forget to replace the cap before you close dishwasher door.

Attention!

Clean up any rinse aid spill during filling with an absorbent cloth to avoid excess foaming during the next wash.

Adjusting Rinse Aid Dispenser

The rinse aid dispenser has six or four settings. Always start with the dispenser set on "2". If spots and poor drying are problems, increase the amount of rinse aid dispensed by removing the dispenser lid and rotating the dial to "3". If the dishes still are not drying properly or are spotted, adjust the dial to the next higher number until your dishes are spot-free. We suggest you to set on "4" (Factory value is "4")

NOTE:

Increase the dose if there are drops of water or lime spots on the dishes after washing. Reduce it if there are sticky whitish streaks on the dishes or a bluish film on glassware or knife blades.

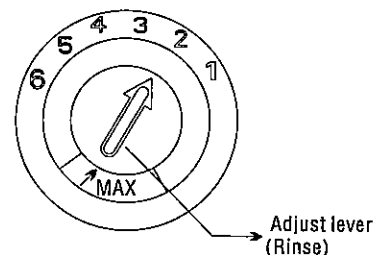

B. Function of Detergent

Detergents with its chemical ingredients are necessary to remove dirt, crush dirt and transport it out of the dishwasher. Most of commercial quality detergents are suitable for this purpose.

Concentrated Detergent

Based on their chemical composition, dishwasher can be split in two basic types:

- conventional, alkaline detergents with caustic components
- low alkaline concentrated detergents with natural enzymes

The use of "heavy" washing programmes in conjunction with concentrated detergents reduces pollution and is good for your dishes; these wash programmes are specially matched to the dirt-dissolving properties of the enzymes of the concentrated detergent. For this reason "heavy" wash programmes in which concentrated detergents are used can achieve the same results that can otherwise only be achieved using "intensive" programmes.

Detergent Tablets

Detergent tablets of different brands dissolve at different speeds. For this reason some detergent tablets cannot dissolve and develop their full cleaning power during short programmes. Therefore please use long programmes when using detergent tablets, to ensure the complete removal of detergent residuals.

Detergent Dispenser

The dispenser must be refilled before the start of each wash cycle following the instructions provided in the Wash Cycle Table. Your dishwashers use less detergent and rinse aid than conventional dishwashers. Generally, only one tablespoon of detergent is needed for a normal wash load. Also, more heavily soiled items need more detergent. Always add the detergent just before starting dishwasher, otherwise it could get damp and will not dissolve properly.

Amount of Detergent to Use

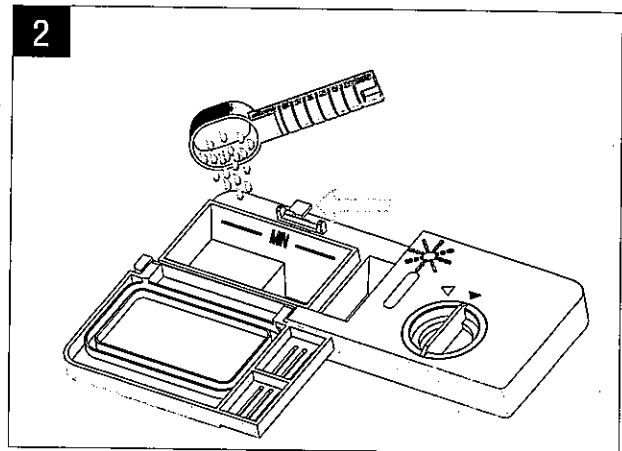
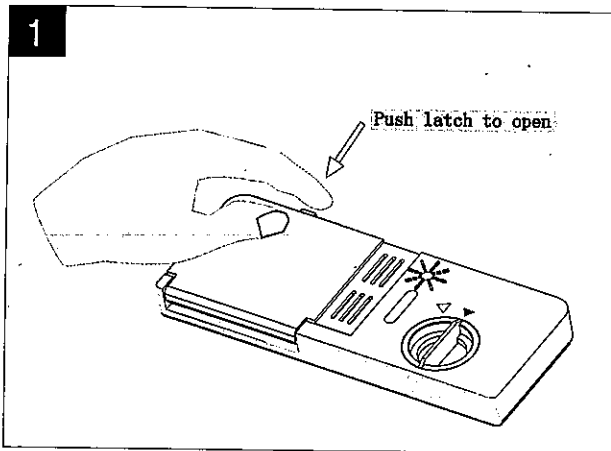

NOTE:

- 1 If the lid is closed: press release button. The lid springs open.
- 2 Always add the detergent just before starting each wash cycle. Only use branded detergent aid for dishwasher.

▲ WARNING!

Dishwasher detergent is corrosive! Take care to keep it out of reach of children.

Proper Use of Detergent

Use only detergent specifically made for use in dishwashers. Keep your detergent fresh and dry. Don't put powder detergent into the dispenser until you're ready to wash dishes.

Fill in detergent

Fill the detergent dispenser with detergent. The marking indicates the dosing levels, as illustrated on right:

- 1 The place of main wash cycle detergent placed, "MIN" means approximately 20g of detergent.
- 2 The place of pre-wash cycle detergent placed, approximately 5g of detergent

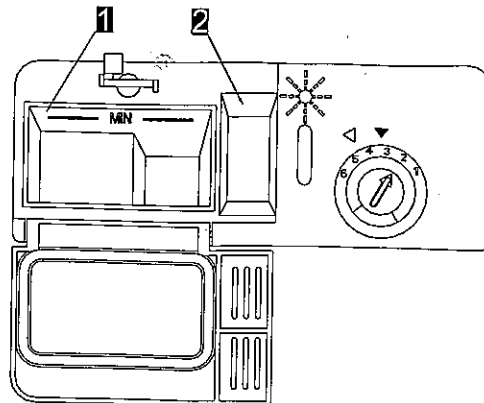

Please observe the manufacturers dosing and storage recommendations as stated on the detergent packaging.

Close the lid and press until it locks in place.

If the dishes are heavily soiled, place an additional detergent dose in the pre-wash detergent chamber. This detergent will take effect during the pre-wash phase.

NOTE

You find information about the amount of detergent for the single programmes on the last page. Please aware, that according to the level soiling and the specific hardness of water differences are possible.

Please observe the manufacturer's recommendations on the detergent packaging.

Detergents

There are 3 sorts of detergents

- 1. With phosphate and with chlorine
- 2. With phosphate and without chlorine
- 3. Without phosphate and without chloride

Use of "2 in 1", "3 in 1", "4 in 1" and "5 in 1" Combination / Compact Detergents

When use "2 in 1", "3 in 1", "4 in 1" or "5 in 1" Combination / Compact Detergents, please pay attention to make sure that the size of the Combination Detergents is fitted to the dispenser, so that Combination Detergents can be ease to put in the dispenser, and dispenser would not be broken.

Attention

Keep all detergents in a safe place out of children's reach.

Always add the detergent in the dispenser just before starting the dishwasher.

HOW TO USE THE 3 IN 1 PROGRAM.

Your dishwasher has a 3 in 1 program which needs not rinse aid but a THREE IN ONE tablet. And this dishwasher comes with a 3 in 1 tablet container as an accessory.

NOTE: Only 3 in 1 program uses 3 in 1 tablet. If using 3 in 1 tablet in other programs, the appliance will not get a best performance.

1. Referring to the below sketch-map, hang the 3 in 1 tablet container on the upper basket.

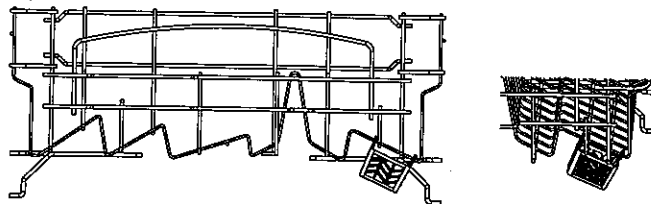

2. Referring to the below sketch map, rotate the upper sprayer and change the location of the container if need to make sure the upper sprayer does not be cumbered by the 3 in 1 tablet container.

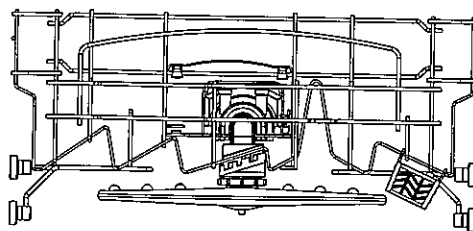

3. Put the 3 in 1 tablet into the container then start the 3 in 1 program.

4. Loading the Dishwasher Racks

For best performance of the dishwasher, follow these loading guidelines. Features and appearance of racks and silverware baskets may vary from your model.

Attention before or after Loading the Dishwasher Racks

Scrape off any large amounts of leftover food. It is not necessary to rinse the dishes under running water. Place objects in the dishwasher in following way:

1. Items such as cups, glasses, pots/pans, etc. are stood upside down.
2. Curve items, or those with recesses, should be at a slant so that water can run off.
3. They are stacked securely and can not tip over.
4. They do not prevent the spray arms from rotating while washing takes place.

Very small items should not be washed in the dishwasher as they could easily fall out of the racks.

Removing the Dishes

To prevent water dripping from the upper back into the lower back, we recommend that you empty the lower basket first and then the upper back.

Loading the Upper Rack

The upper rack is designed to hold more delicate and lighter dishware such as glasses, coffee and tea cup and saucers, as well as plates, small bowls and shallow pans (as long as they are not too dirty).

Position the dishes and cookware so that they do not get moved by the spray of water.

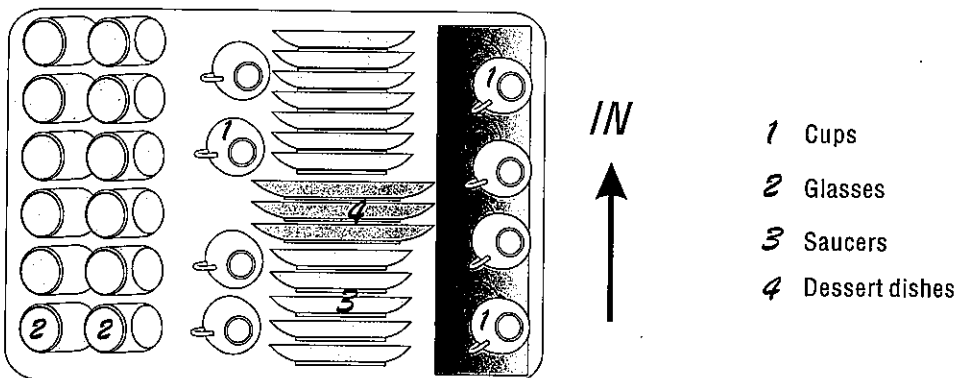

How to use the upper rack (14 place settings)

The upper rack is for more delicate and lighter dishware
Such as glasses, coffee & tea cups, saucers, plates, bowls,
And shallow pans (provided these are not too dirty).

Position the dishes and cookware so that they do not get
Moved by the spray of water. Always place glasses, cups &
Bowls upside down.

Note:

Your dishwasher comes with an adjustable top rack (basket)
Pictured at right. Its height can be adjusted by lifting the
Handle in a downward or upward direction. (pls see the
Figures on the right: position 1 & positong 2.)

Notice:

Ensure the metal rod is located in its correct position.

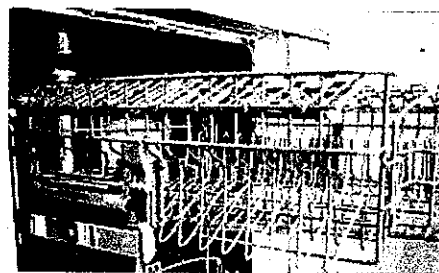

POSITION 1

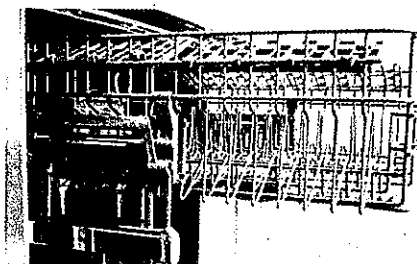

POSITION 2

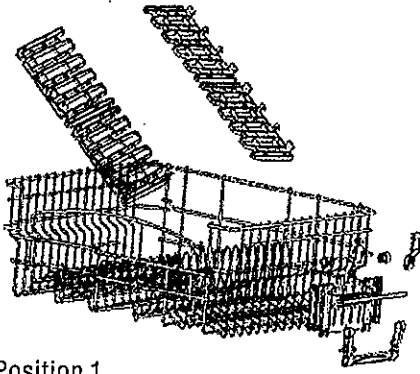

NOTE: The upper rack has side flaps (pictured at left Above basket). There are 4 (2 on each side). These can be Adjusted into 2 positions = position 1 (high) and position 2 (low).

To move the flaps between these positions, locate the large hinges Clip each flap to the upper rack. There are two of these at Either end of each flap. Gently pull both clips off the wire rack And move the flap to the desired position. Be careful if you have Long fingernails!

Position 1

The upper position will accommodate items such as glass tumblers (placed beneath flap) and wine Glasses. Wine glasses can be placed upside down so that the neck rests in the grooves at side of flap With the base of the glass facing upward.

Position 2

When the flaps are moved to the lower position, they can be used to hold additional tumblers, cups And mugs. Always check that you are only placing items on the flaps that will clear the ceiling height Of your dishwasher when you push the rack back in. Be particularly careful with long-stemmed Glassware such as champagne glasses breakage hazard!

Loading the Lower Rack

We recommend that you place large items which are most difficult to clean into the lower rack: pots, pans, lids, serving dishes and bowls, as shown in the figure to the right. It is preferable to place serving dishes and lids on the side of the racks in order to avoid blocking the rotation of the top spray arm.

Pots, serving bowls, etc. must always be placed top down.
Deep pots should be slanted to allow water to flow out.

The bottom rack feature fold down tine rows so that larger or more pots and pans can be loaded.

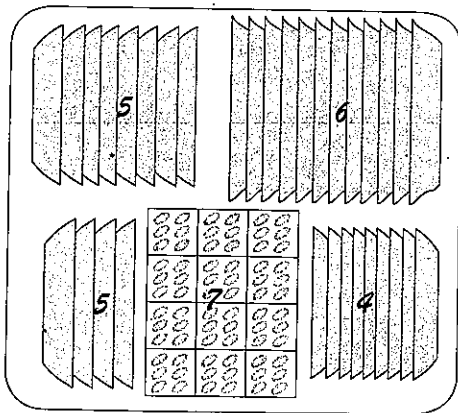

- 4 Dessert dishes
- 5 Soup plates
- 6 Dinner plates
- 7 Silverware basket

Silverware Basket

Silverware should be placed in the silverware basket with handles at the bottom: If the rack has side baskets, the spoon should be loaded individually into the appropriate slots, especially long utensils should be placed in the horizontal position at the front of the upper rack.

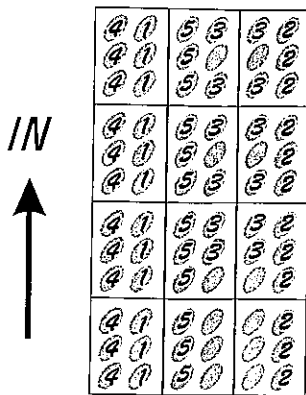

- 1 Forks
- 2 Soup spoons
- 3 Dessert spoons
- 4 Teaspoons
- 5 Knife



▲ WARNING!

Do not let any item extend through bottom.

For washing in the dishwasher the following cutlery/dishes Are not suitable

- Cutlery with wooden, horn china or mother-of-pearl handles
- Plastic items that are not heat resistant
- Older cutlery with glued parts that is not temperature resistant
- Bonded cutlery items or dishes
- Pewter or cooper items
- Lead crystal glass
- Steel items subject to rusting
- Wooden platters
- Items made from synthetic fibres

Are of limited suitability

- Some types of glasses can become dull after a large number of washes
- Silver and aluminium parts have a tendency to discolour during washing
- Glazed patterns may fade if machine washed frequently

NOTE

Do not put in items that are dirty of cigarette ash, candle wax, lacquer or paint. If you buy new dishes please make sure that they are suitable for dishwashers.

NOTE

Please do not overload your dishwasher. There is only space for 12 standard dishes. Do not use dish that is not suitable for dishwashers. This is important for good results and for reasonable energy consume.

Loading cutlery and dishes

- Before loading the dishes, you should:
- Remove large left-over
- Soften remnants of burnt food in pans

When loading the dishes and cutlery, please note:

- Dishes and cutlery must not impede the rotation of the spray arms
- Load hollow items such as cups, glasses, pans etc. with the opening downwards so that water cannot collect in the container or a deep base.

- Dishes and items of cutlery must not lie inside one another, or cover each other
- To avoid damage to glasses, they must not touch
 - Load large items which are most difficult to clean into the lower rack
 - The upper rack is designed to hold more delicate and lighter dishware such as glasses, coffee and tea cups

Attention!

Long bladed knives stored in an upright position are a potential hazard!
Long and/or sharp items of cutlery such as carving knives must be positioned horizontally in the upper basket.

Damage to glassware and other dishes

Possible causes:

- Type of glass or manufacturing process. Chemical composition of detergent.
- Water temperature and duration of dishwasher programme.

Suggested remedy:

- Use glassware or porcelain dishes that have been marked dishwasher-proof by the manufacturer
- Use a mild detergent that is described as kind of dishes. If necessary, seek further information from detergent manufacturers.
- Select a programme with as low a temperature.
- To prevent damage, take glass and cutlery out of the dishwasher as soon as possible after the programme has ended.







At the End of the Wash Cycle

When the working cycle has finished, the buzzer of dishwasher will mooring 8 seconds, then stop. Turn of the appliance using the ON/OFF button, shut off the water supply and open the door of the dishwasher. Wait a few minutes before unloading the dishwasher to avoid handling the dishes and utensils while they are still hot and more susceptible to breakage. They will also dry better.

Starting the Washing Programme

5. Starting a washing programme

WASH CYCLE TABLE

Program	Cycle	Cycle Selection Information	Description of Cycle	Detergent pre/main	Running time(min)	Energy (Kwh)	Water (l)	Rinse Aid
Auto	Auto	For all soiled loads, such as pots, pans, casserole dishes and dishes that have been sitting with dried food on them for a while.	Pre-wash (40 °C) Autowash (50-60 °C) Rinse Rinse (70 °C) Drying.	<u>3in1</u> (or5/25g)	160	1.1~1.4	11~14.5	☆
3 In1		For normally soiled loads, such as pots, plates, glasses and lightly soiled pans. standard daily cycle.	Pre-wash pre-wash wash(45 °C) rinse(70 °C) drying	3in1	160	1.10	16.2	
Intensive		For the heaviest soiled loads, such as pots, pans, casserole dishes and dishes that have been sitting with dried food on them for a while.	Pre-wash(45 °C) Wash (50 °C) Rinse (70 °C) Drying	5/25 g.	150	1.55	17.7	☆
Heavy		For normally soiled loads, such as pots, plates, glasses and lightly soiled pans. standard daily cycle. (IEC-EN 50242)	Pre-wash Pre-wash Wash (50 °C) Rinse (70 °C) Drying	5/25 g.	150	1.25	17.4	☆
Normal		For normal soiled loads, such as plates, glasses, bowls and lightly soiled pans.	Pre-wash Pre-wash Wash (45 °C) Rinse (55 °C) Drying	25 g.	25 g.	0.65	13.7	☆
Rapid		A shorter wash for lightly soiled loads that do not need drying.	Wash (40 °C) Rinse (50 °C)	20 g.	50	0.6	9.9	☆
Soak		To rinse dishes that you plan to wash later that day.	Pre-wash		8	0.01	3.7	

Turning on the Appliance

Starting a wash cycle...

1. Draw out the lower and upper basket, load the dishes and push them back. It is commended that loading the lower basket first, than the upper one (see the section entitled "Loading the Dishwasher").
2. Pour in the detergent (see the section entitled "Detergent and Rinse Aid").
3. Turn on the water supply to full pressure.
4. Insert the plug into the socket. The power supply is 220-240 VAC 50 HZ, the specification of the socket is 12 A 250 VAC. Make sure that the water supply is turned on to full pressure.
5. Open the door , press the ON/OFF button , and the ON/OFF light will turn on. Press the "prog." Button to select a desired "Wash cycle".(see the section entitled."Wash Cycle Table".)
6. With a little force to ensure the door is properly closed.
NOTE: A click could be heard when the door is closed perfectly. When the washing is over, you can shut off the switch by pressing ON/OFF button.
7. When the washing is over, you can open the door and then shut off the switch by pressing on/off button..

Change the Programme . . .

Premise: A cycle that is underway can only be modified if it has only been running for a short time. Otherwise, the detergent may have already been released, and the appliance may have already drained the wash water. If this is the case, the detergent dispenser must be refilled (see the section entitled " Loading the Detergent ").

Open the door, Press current prog. Button more than three seconds to cancel the program ,then you can change the program to the desired cycle setting Then, close the door to start washing.

NOTE: If you open the door when washing, the machine will pause. When you close the door , the machine will keep on working after 10 seconds.



At the end of the wash cycle

At the end of a wash cycle, the time display will flash for 8 seconds while the buzzer sound. However, when the delay start function is activated, the time display will flash for 8 seconds, but the buzzer will not sound.

NOTE:

If all the lights begin to glimmer, that indicates the machine is out of order, please turn off the main power and water supply before calling a service.

Forget to Add a Dish?

A forgotten dish can be added any time before the detergent cup opens.

- 1 Open the door a little to stop the washing.
- 2 After the spray arms stop working, you can open the door completely.
- 3 Add forgotten dishes.
- 4 Close the door, then press the start/reset button, the dishwasher will work after ten seconds.

▲ WARNING!

It is dangerous to open the door when washing, because the hot water may scald you.

Switch Off the Dishwasher

The program light is on but isn't blinking, only in this case the program is ended.

1. Switch off the dishwasher by pressing the ON/OFF button.
2. Turn off the water tap!

Open the door carefully. Hot steam may escape when the door is opened!

- Hot dishes are sensitive to knocks. The dishes should be allowed to cool down around 15 minutes before removing from the appliance.
- Open the dishwasher's door, leave it ajar and wait a few minutes before removing the dishes. In this way they will be cooler and the drying will be improved.

Unloading the dishwasher

It is normal that the dishwasher is wet inside.

Empty the lower basket first and then the upper one. This will avoid water dripping from the upper basket onto the dishes in the lower one.

Filtering System

The filter prevents larger remnants of food or other objects from getting inside the pump. This residue can occasionally clog up the filters.

The filter system consists of a coarse filter, a flat (Main filter) and a microfilter (Fine filter).

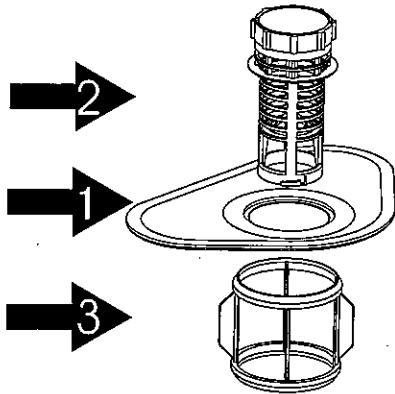

Main filter **1**

Food and soil particles trapped by this filter are pulverized by a special jet on the lower spray arm and washed down the drain.

Coarse filter **2**

Larger items, such as pieces of bone or glass, that could clog the drain are trapped in the coarse filter. To remove an item caught in this filter, gently squeeze the taps on the top of this filter and lift it out.

Fine filter **3**

This filter holds soil and food residue in the sump area and prevents it from being redeposited on the dishes during a cycle.

- Inspect the filters for obstructions every time the dishwasher has been used.
- By unscrewing the coarse filter, you can remove the filter system. Remove any food remnants and clean the filters under running water.

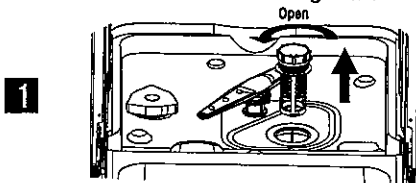

step 1 : contrarotate the Coarse filter, and then lift it up;

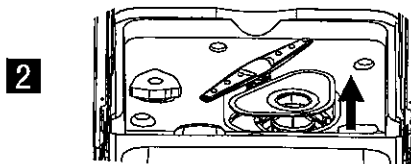

step 2 : lift the Main filter up

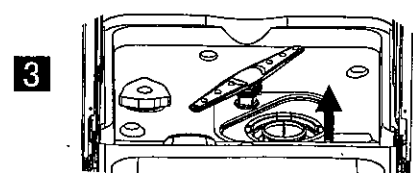

step 3 : lift the Fine filter up

NOTE:

If done from step 1 to step 3, the filter system will be removed; while if done from step 3 to step 1, the filter system will be installed.

Caring for the Dishwasher

To clean the control panel use a lightly dampened cloth then dry thoroughly. To clean the exterior use a good appliance polish wax.

Never use sharp objects, scouring pads or harsh cleaners on any part of the dishwasher.

Protect Against Freezing

If your dishwasher is left in an unheated place during the winter, ask a service technical to:

1. Cut off electrical power to the dishwasher.
2. Turn off the water supply and disconnect the water inlet pipe from the water valve.
3. Drain water from the inlet pipe and water valve. (Use a pan to catch the water)
4. Reconnect the water inlet pipe to the water valve.
5. Remove the filter in the tub the bottom and use a sponge to use up water in sump.

6. Maintenance and Cleaning

Cleaning the Spray Arms

It is necessary to clean the spray arms regularly for hard water chemicals will clog the spray arm jets and bearings. To remove the spray arms, screw off the nut clockwise to take out the washer on top of the spray arm and remove the arm. Wash the arms in soapy and warm water and use a soft brush to clean the jets. Replace them after rinsing them thoroughly.

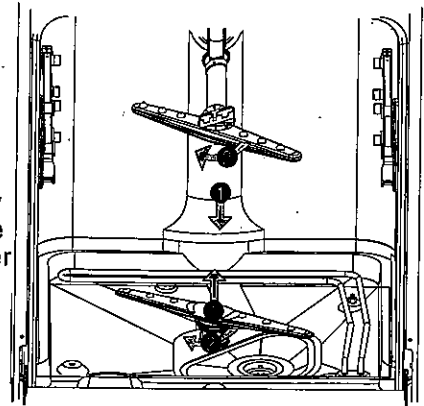

Filter assembly

For best performance and results, the filter assembly must be cleaned. The filter efficiently removes food particles from the wash water, allowing it to be recirculated during the cycle. For this reason, it is a good idea to remove the larger food particles trapped in the filter after each wash cycle by rinsing the semicircular filter and cup under running water. To remove the filter assembly, pull on the cup handle in the upward direction. The entire filter assembly should be cleaned once a week.

To clean the coarse filter and the fine filter, use a cleaning brush. Then, reassemble the filter parts as shown in the figures left and reinsert the entire assembly in the dishwasher, positioning in its seat and pressing downward.

The dishwasher must never be used without the filters. Improper replacement of the filter may reduce the performance level of the appliance and damage dishes and utensils.

▲ **WARNING!**

Never run the dishwasher without the filters in place. When cleaning the filters, don't knock on them. Otherwise, the filters could be contorted and the performance of dishwasher could be debased.

Cleaning the Door

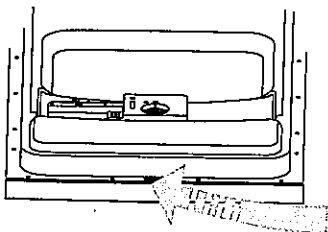

To clean the edge around the door, you should use only a soft warm, damp rag. To prevent penetration of water into the door lock and electrical components, do not use a spray cleaner of any kind.

Also, never use abrasive cleaners or scouring pads on the outer surfaces because they will scratch the finish. Some papers towels can also scratch or leave marks on the surface.

▲ **WARNING!**

Never use a spray cleaner to clean the door panel for it could damage the door lock and electrical components. It is not allowed to use the abrasive agent or some paper towel because of the risk of scratching or leaving spots on the stainless steel surface.

How to Keep Your Dishwasher in Shape

❑ After Every Wash

After every wash, turn off the water supply to the appliance and leave the door slightly ajar so that moisture and odors are not trapped inside.

❑ Remove the Plug

Before cleaning or performing maintenance, always remove the plug from the socket. Do not run risks.

❑ No Solvents or Abrasive Cleaning

To clean the exterior and rubber parts of the dishwasher, do not use solvents or abrasive cleaning products. Rather, use only a cloth and warm soapy water. To remove spots or stains from the surface of the interior, use a cloth dampened with water and a little white vinegar, or a cleaning product made specifically for dishwashers.

❑ When You Go on Holiday

When you go on holiday, it is recommended that you run a wash cycle with the dishwasher empty and then remove the plug from the socket, turn off the water supply and leave the door of the appliance slightly ajar. This will help the seals last longer and prevent odors from forming within the appliance.

❑ Moving the Appliance

If the appliance must be moved, try to keep it in the vertical position. If absolutely necessary, it can be positioned on its back.

❑ Seals

One of the factors that cause odors to form in the dishwasher is food that remains trapped in the seals. Periodic cleaning with a damp sponge will prevent this from occurring.

7. Installation instruction

About Electricity Connecting

⚠ CAUTION, for personal safety:

DO NOT USE AN EXTENSION CORD OR AN ADAPTER PLUG WITH THIS APPLIANCE.

DO NOT, UNDER ANY CIRCUMSTANCES, CUT OR REMOVE THE THIRD GROUNDING PRONG FROM THE POWER CORD.

Electrical Requirements

Please see the rating label to know the rating voltage and connect the dishwasher to appropriate power supply, which has a required fuse 16 amp. Time delay fuse or circuit breaker recommended and provide separate circuit serving only this appliance.

Electrical Connection

⚠ Insure proper ground exists before use

After making sure that the voltage and the frequency values for the current in the home correspond to those on the rating plate and that the electrical system is sized for the maximum voltage on the rating plate, insert the plug into an electrical socket which is earthed properly. If the electrical socket to which the appliance must be connected is not appropriate for the plug, replace the socket, rather than using a adaptor or the like as they could cause overheating and burns.

⚠ Insure proper ground exists before use



GROUNDING INSTRUCTIONS

- ❑ This appliance must be grounded. In the event of a malfunction or breakdown, grounding will reduce the risk of electric shock by providing a path of least resistance of electric current. This appliance is equipped with a cord having an equipment-grounding conductor and a grounding plug. The plug must be plugged into an appropriate outlet that is installed and grounded in accordance with all local codes and ordinances.

⚠ WARNING!

- ❑ Improper connection of the equipment-grounding conductor can result in a risk of electric shock. Check with a qualified electrician or service representative if you are in doubt whether the appliance is properly grounded. Do not modify the plug provided with the appliance; if it is not fit for the outlet. Have a proper outlet installed by a qualified electrician.

▲ WARNING!

In order to avoid that there is more water staying in the inlet hose, please close the hydrant after using. (For the models: no safety inlet hose.)

Cold Water Connection

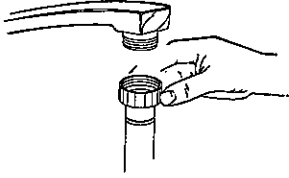

Connect the cold water supply hose to a threaded 3/4 (inch) connector and make sure that it is fastened tightly in place.

If the water pipes are new or have not been used for an extended period of time, let the water run to make sure that the water is clear and free of impurities. If this precaution is not taken, there is a risk that the water inlet can get blocked and damage the appliance.

Hot Water Connection

The water supply to the appliance can also be connected to the house hot water line (centralized system, heating system), as long as it does not exceed a temperature of 60°C. In this case, the wash cycle time will be shortened by about 15 minutes and the wash efficiency slightly reduced.

The connection must be made to the hot water line following the same procedures as those for the connection to the cold water line.

Positioning the Appliance

Position the appliance in the desired location. The back should rest against the wall behind it, and the sides, along the adjacent cabinets or wall. The dishwasher is equipped with water supply and drain hoses that can be positioned to the right or the left to facilitate proper installation.

Levelling the Appliance

Dishwasher must be level for proper dish rack operation and wash performance.

- 1 Place level on door and rack track inside the tub as shown to check that the dishwasher is level.
- 2 When level the dishwasher, please pay attention not to let the dishwasher tip over.

Drain hose Connection

Insert the drain hose into a drain pipe with a minimum diameter of 40 mm, or let it run into the sink, making sure to avoid bending or crimping it. Use the special plastic support that comes with the appliance. The free end of the hose must be at a height between 400 and 1000mm and must not be immersed in water.

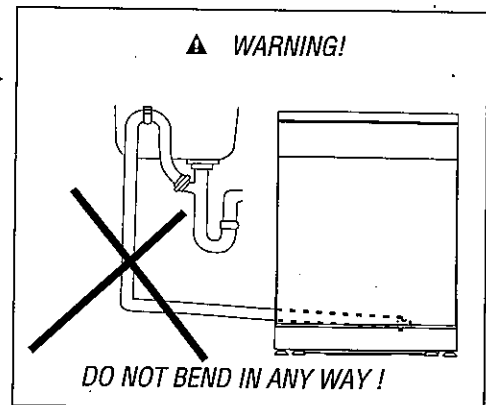
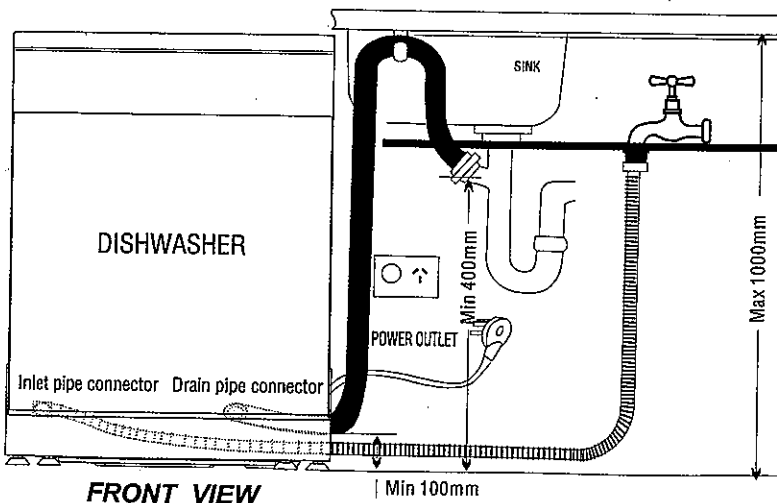

How to Drain Excess Water From Hoses

If the sink is 1000 higher from the floor, the excess water in hoses cannot be drained directly into the sink. It will be necessary to drain excess water from hoses into a bowl or suitable container that is held outside and lower than the sink.

▲ WARNING!

In order to avoid more water staying in the inlet hose; please close the hydrant after using. (For the models: no safety inlet hose.)

Water Outlet

Connect the water drain hose. The drain hose must be correctly fitted to avoid water leaks. Ensure that the water inlet hose is not kinked or squashed.

Extension Hose

If you need a drain hose extension, observe to use a similar drain hose. It must be no longer than 4 metres; otherwise the cleaning effect of the dishwasher could be reduced.

Syphon Connection

The waste connection must be at a height of between 50 cm (minimum) and 100 cm (maximum) from the bottom of the dish. The water drain hose should be fixed by a hose clip.

Aquasafe

The Aquasafe System is a safety valve system, preventing you from water leaks. If the water inlet hose starts to leak during a wash cycle, the safety valve cuts off the running water. Do not immerse the water inlet hose or the safety valve in water, because the electrical cable for the safety valve is in the double-walled water inlet hose. If water inlet hose or the safety valve is damaged, remove the main plug immediately. Do not enlarge or shorten the inlet hose because it contains electric parts.

● Start of dishwasher

The followings should be checked before starting the dishwasher.

- 1 Whether the dishwasher is level and fixed
- 2 Whether the inlet valve is opened
- 3 Whether there is leakage at the connections of the conducts
- 4 Whether the wires are tightly connected
- 5 Whether the power is switched on
- 6 Whether the inlet and drain hoses are knotted
- 7 All packing materials and printings should be taken out from the dishwasher

● Attention

After installation, please put this manual into the bags of printings. The content of this manual is very helpful to the users.

8. Troubleshooting Tips

Before Calling for Service

Review the charts on the following pages may make you be free of calling for service.



<i>Problem</i>	<i>Possible Causes</i>	<i>What To Do</i>
<i>Dishwasher doesn't run</i>	Fuse blown, or the circuit breaker acted	Replace fuse or reset circuit breaker. Remove any other appliances sharing the same circuit with the dishwasher
	Power supply is not turned on	Make sure the dishwasher is turned on and the door is closed securely. Make sure the power cord is properly plugged into the wall socket.
	Water pressure is low	Check that the water supply is connected properly and the water is turned on.
<i>Noise</i>	Some audible sounds are normal	Sound from soft food shredding action and detergent cup opening.
	Utensils are not secure in the baskets or something small has dropped into the basket	To ensure everything is secured in the dishwasher.
	Motor hums	Dishwasher has not been used regularly. If you do not use it often, remember to set it to fill and pump out every week, which will help keep the seal moist.
<i>Suds in the tub</i>	Improper detergent	Use only the special dishwasher detergent to avoid suds. If this occurs, open the dishwasher and let suds evaporate. Add 1 gallon of cold water to the tub. Close and latch the dishwasher, then Start the wash cycle to drain out the water .. Repeat if necessary.
	Spilled rinse agent	Always wipe up rinse agent spills immediately.
<i>Stained tub interior</i>	Detergent with colorant was used	Make sure that the detergent is the one without colorant.
<i>Dishes are not dried</i>	Rinse agent dispenser is empty	Make sure that the rinse agent dispense is filled.
<i>Dishes and flatware not clean</i>	Improper program	Select stronger program
	Improper rack loading	Make sure that the action of the detergent dispenser and spray arms are not blocked by large dishware.
<i>Spots and filming on glasses and flatware</i>	<ol style="list-style-type: none"> 1 Extremely hard water 2 Low inlet temperature 3 Overloading the dishwasher 4 Improper loading 5 Old or damp powder detergent 6 Empty rinse agent dispenser 7 Incorrect dosage of detergent 	<p>To remove spots from glassware:</p> <ol style="list-style-type: none"> 1 Take out all metal utensils out of the dishwasher. 2 Do not add detergent. 3 Choose the longest cycle. 4 Start the dishwasher and allow it to run for about 18 to 22 minutes, then it will be in the main wash. 5 Open the door to pour 2 cups of white vinegar into the bottom of the dishwasher. 6 Close the door and let the dishwasher complete the cycle. If the vinegar does not work: Repeat as above, except use 1/4 cup (60 ml) of citric acid crystals instead of vinegar.

Before calling for service . . .

Problem	Possible Causes	What To Do
Cloudiness on glassware	Combination of soft water and too much detergent	Use less detergent if you have soft water and select a shortest cycle to wash the glassware and to get them clean.
Yellow or brown film on inside surfaces	Tea or coffee stains	using a solution of 1/2 cup of bleach and 3 cups warm water to remove the stains by hand. ▲ WARNING You have to wait for 20 minutes after a cycle to let the heating elements cool down before cleaning interior; otherwise, burns will happen.
	Iron deposits in water can cause an overall film	You have to call a water softener company for a special filter.
White film on inside surface	Hard water minerals	To clean the interior, use a damp sponge with dishwasher detergent and wear rubber gloves. Never use any other cleaner than dishwasher detergent for the risk of foaming or suds.
Detergent cup lid won't latch	Dial is not in the OFF position	Turn the Dial to OFF position and slide the door latch to the left.
Detergent left in dispenser cups	Dishes block detergent cups	Re-loading the dishes properly.
Steam	Normal phenomenon	There is some steam coming through the vent by the door latch during drying and water draining.
Black or gray marks on dishes	Aluminum utensils have rubbed against dishes	Use a mild abrasive cleaner to eliminate those marks.
Water standing in the bottom of the tub	This is normal	A small amount of clean water around the outlet on the tub bottom keeps the water seal lubricated.
Water flow out	Damaged or defective drain pump	Replace the drain pump
Dishwasher leaks	Overfill dispenser or rinse aid spills	Be careful not to overfill the rinse aid dispenser. Spilled rinse aid could cause oversudsing and lead to overflowing. Wipe away any spills with a damp cloth.
	Dishwasher isn't level	Make sure the dishwasher is level.

ERROR CODES

When some malfunctions come on, the appliance will display error codes to warn you.

Codes	Meanings	Possible Causes
E1	Longer inlet time.	Faucets is not opened.
E3	Longer heating time, but not reaching required temperature	Malfunction of temperature sensor or of heating element.
E4	Overfilled.	Too much inlet water. .
E6,E7	Abnormal temperature	Short circuit or break of temperature sensor.

WARNING!

If overflow occurs, turn off the main water supply before calling a service. If there is water in the base pan because of an overflow or small leak, the water should be removed before restarting the dishwasher.

Technical information

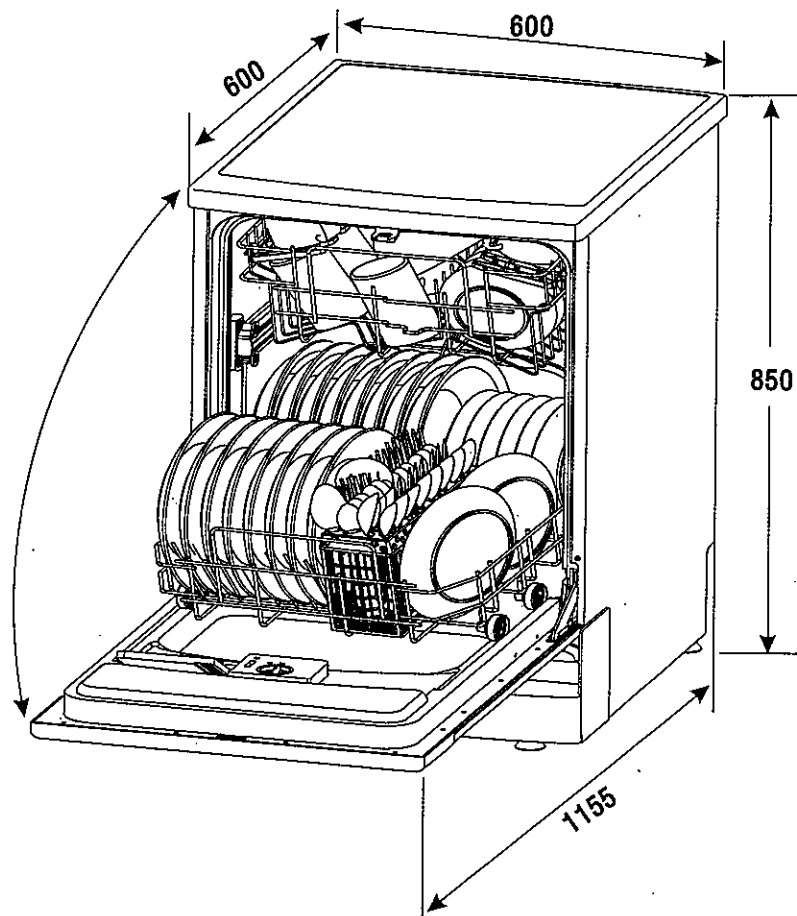

Height :	850mm
Width :	600mm
Depth :	600mm
Voltage connected Load :	see rating label
Water pressure:	0.04-1.0MPa
Hot water connection :	max 60 °C
Power supply:	see rating label
Capacity:	14 Place settings